

REVISIONS

ZONE	REV	DESCRIPTION	DATE	APPROVED
A				

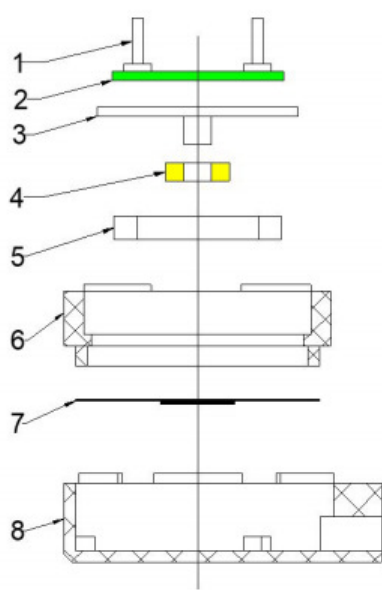

No.	Part Name	Material	Quantity
1	PIN	Copper	2
2	PCB	Epoxy Glass Fiber Cloth + Copper	1
3	Core	Ferrum	1
4	Coil	Copper	1
5	Magnet Ring	NdFeB	1
6	Case	PPO	1
7	Diaphragm	Ferrum	1
8	Case	PPO	1

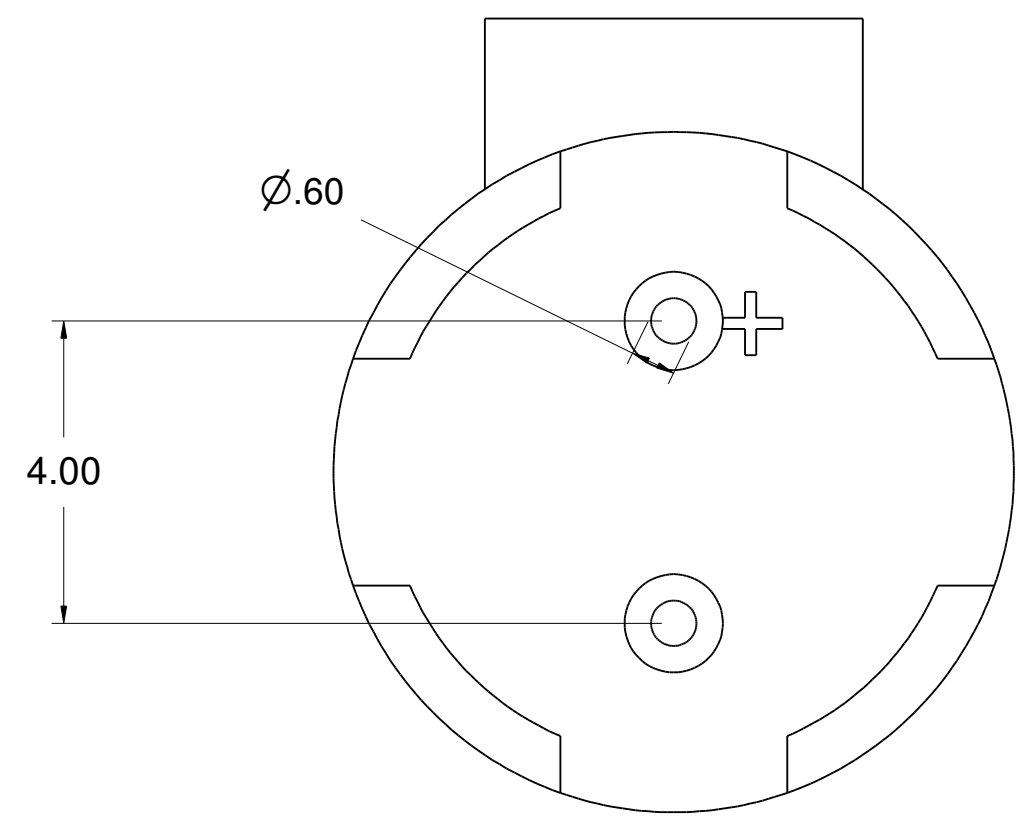
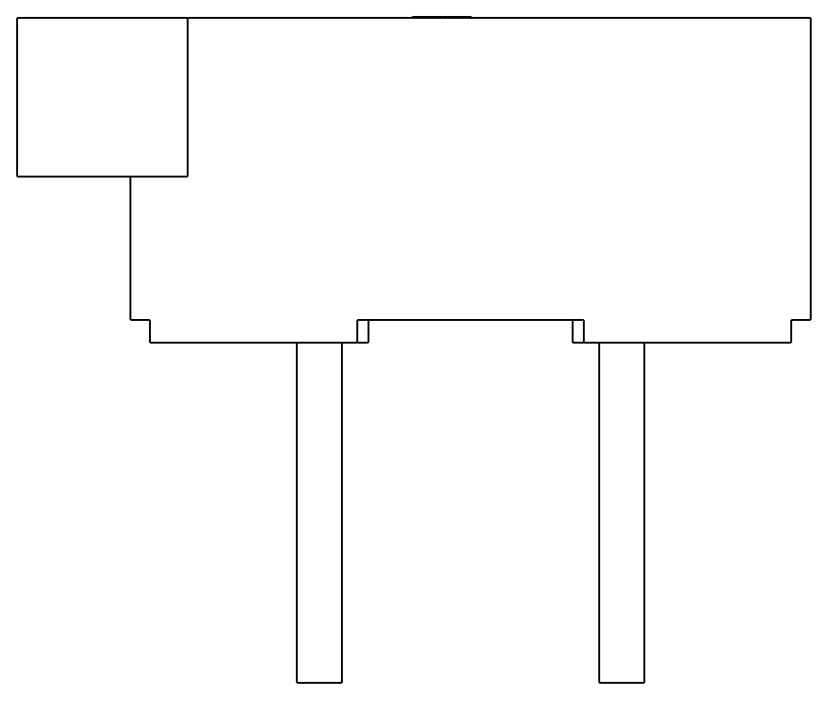
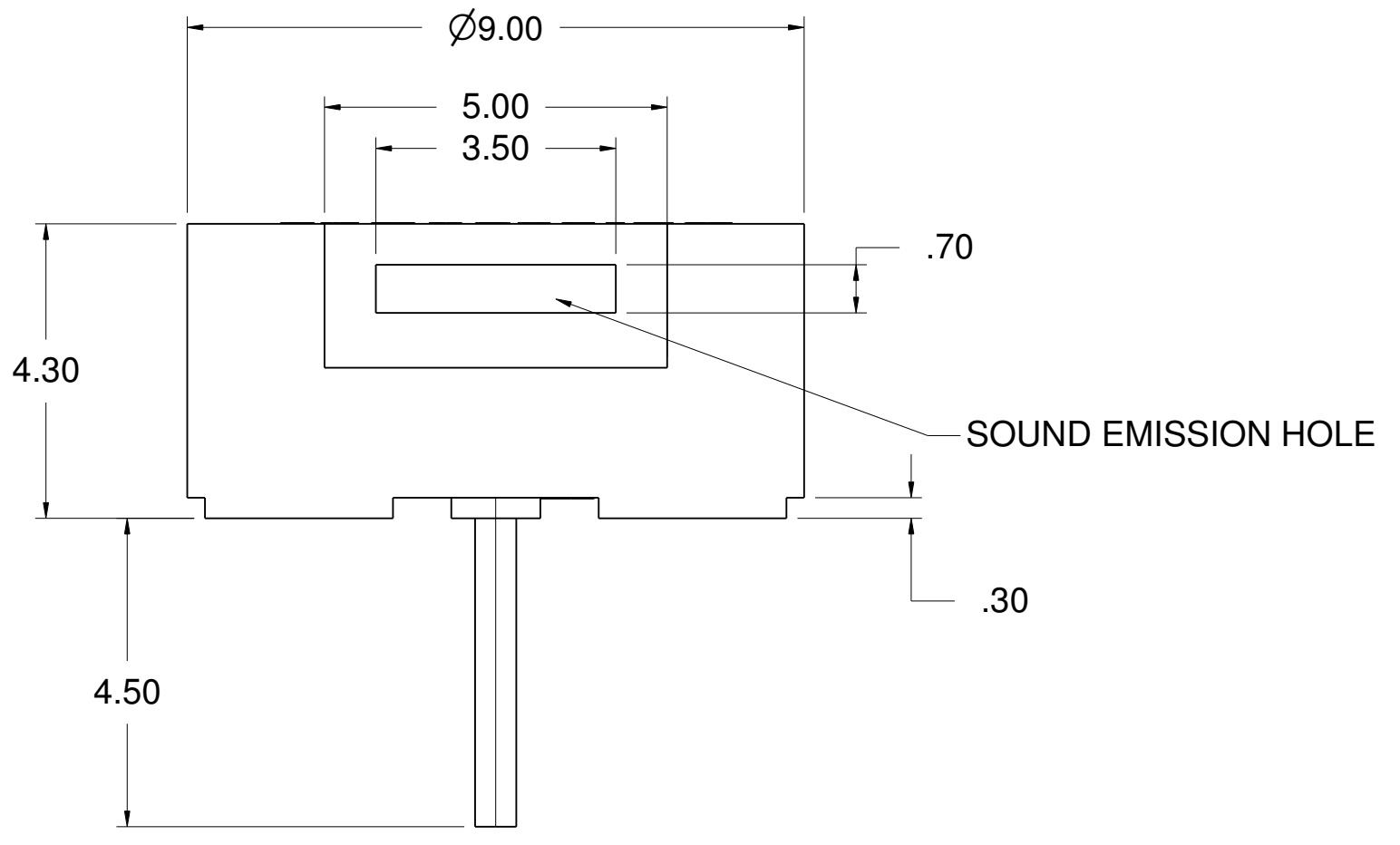
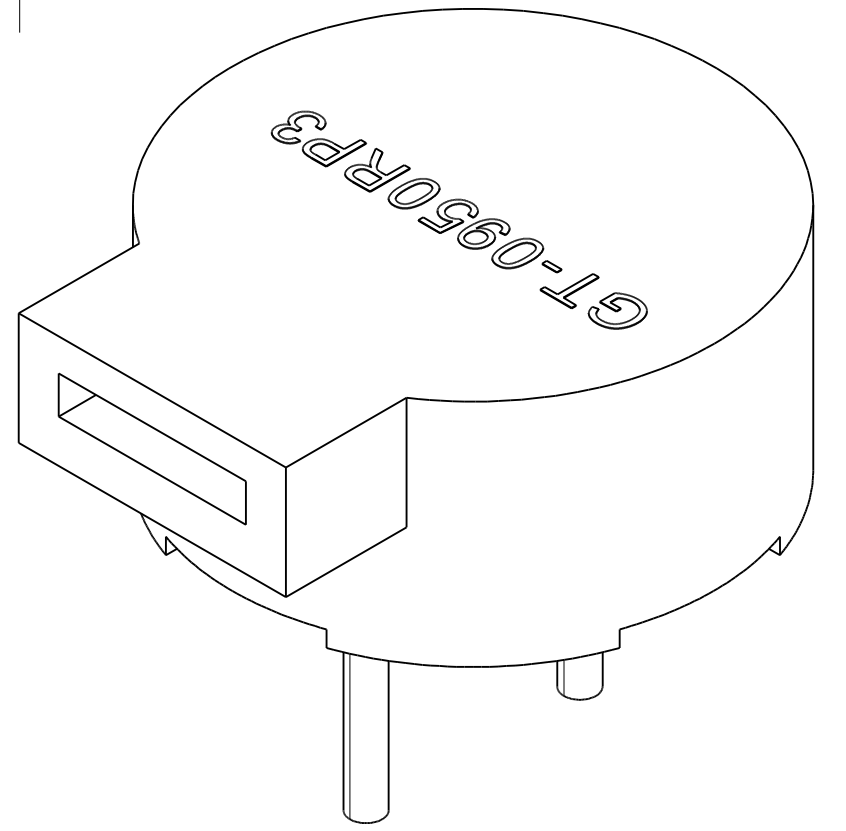
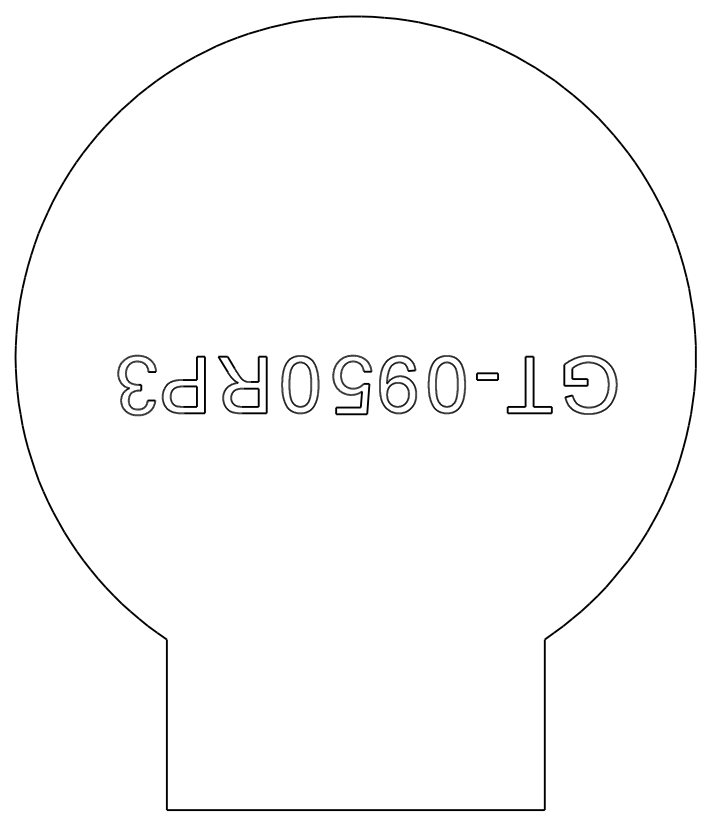

211 N. FIRST ST.
MINNEAPOLIS, MN 55401

ALL DIMENSIONS +/- .5MM UNLESS NOTED	DRAWN BWS	DATE 12/01/2019	ALL DIMENSIONS PROVIDED FOR REF. ONLY	
	CHECKED		GT-0950RP3	
REFER TO 3D MODEL FOR MISSING DIMENSIONS	QA		SIZE C	
	MFG		SCALE 1:1	SHEET 1 OF 1
	APPROVED			