

REVISIONS				
ZONE	REV	DESCRIPTION	DATE	APPROVED

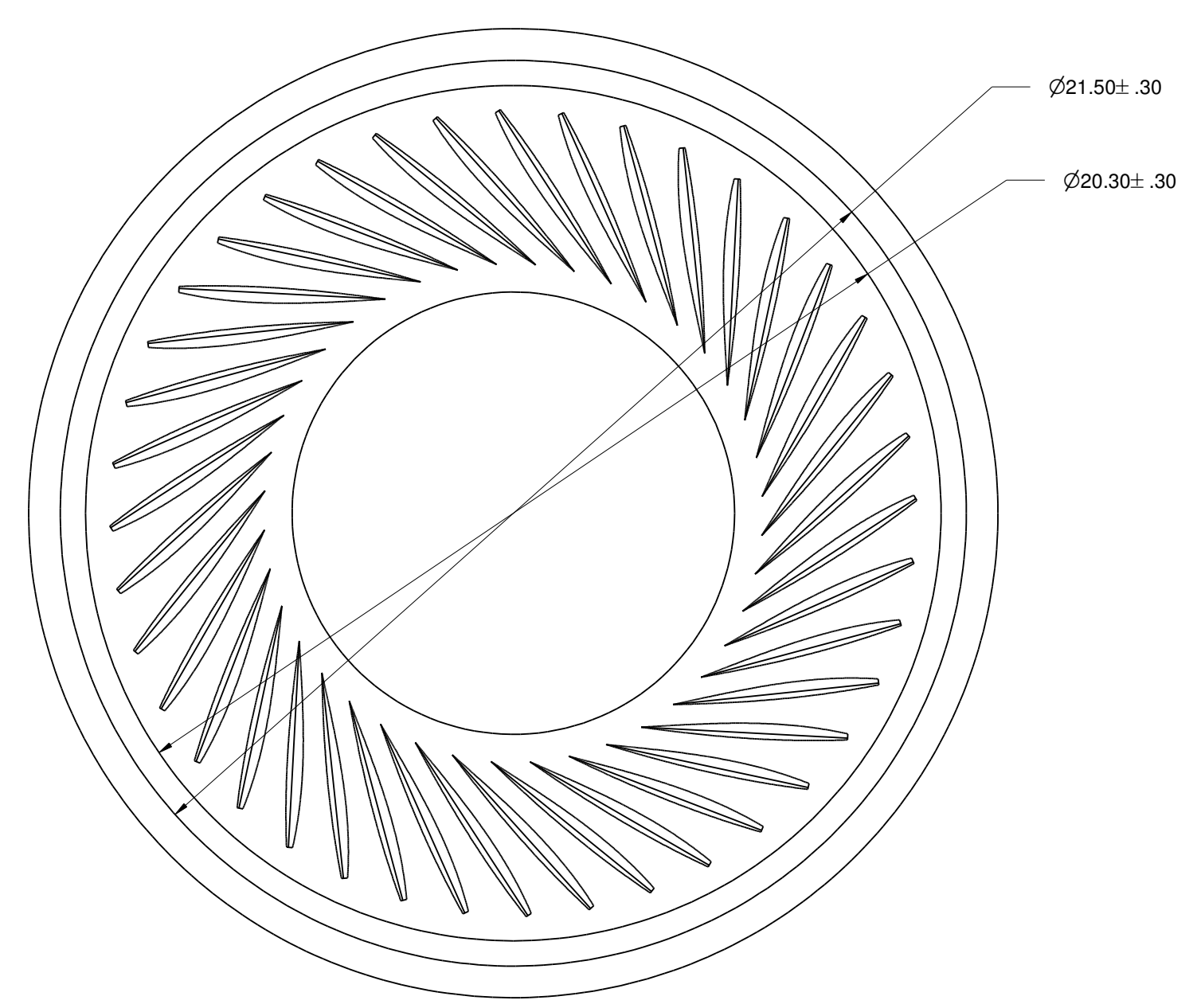

ALL TOLERANCES +/- .5MM UNLESS NOTED

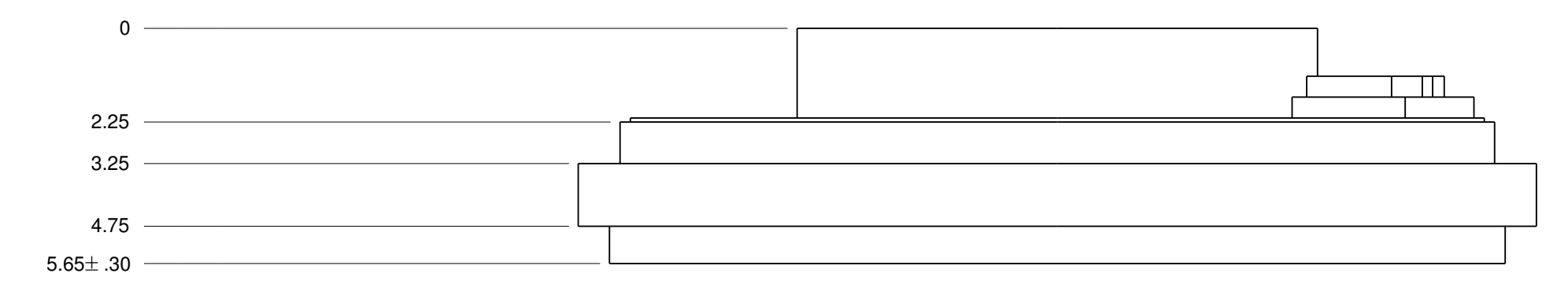
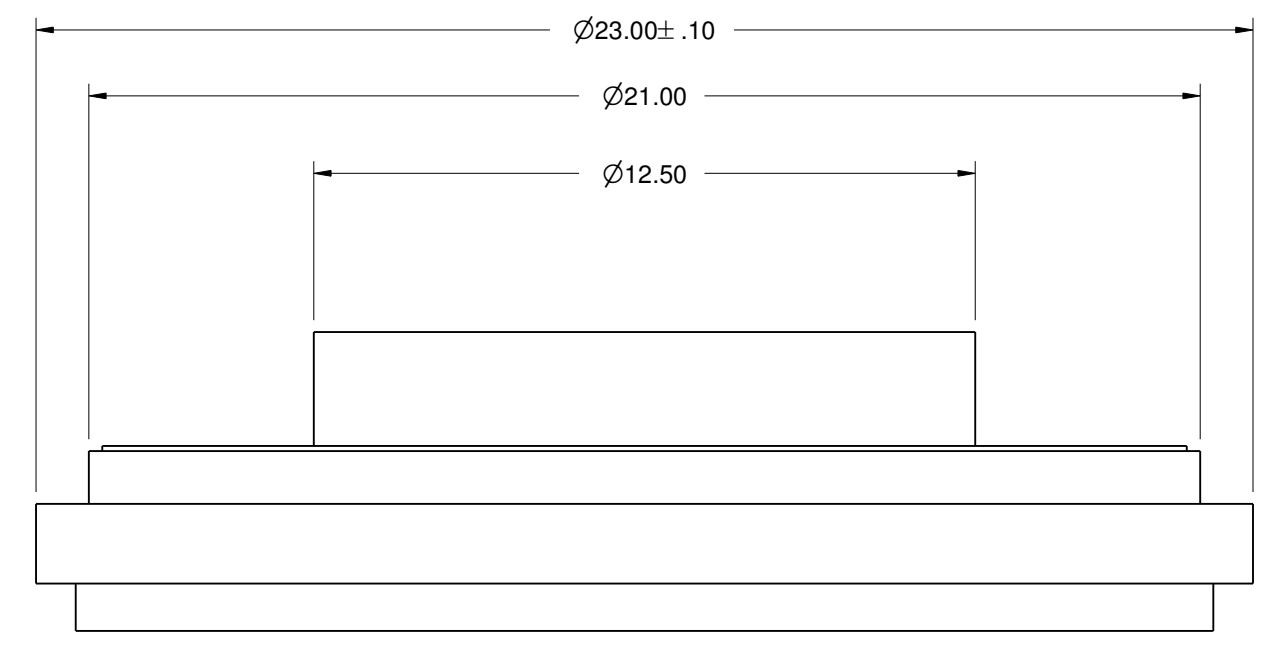
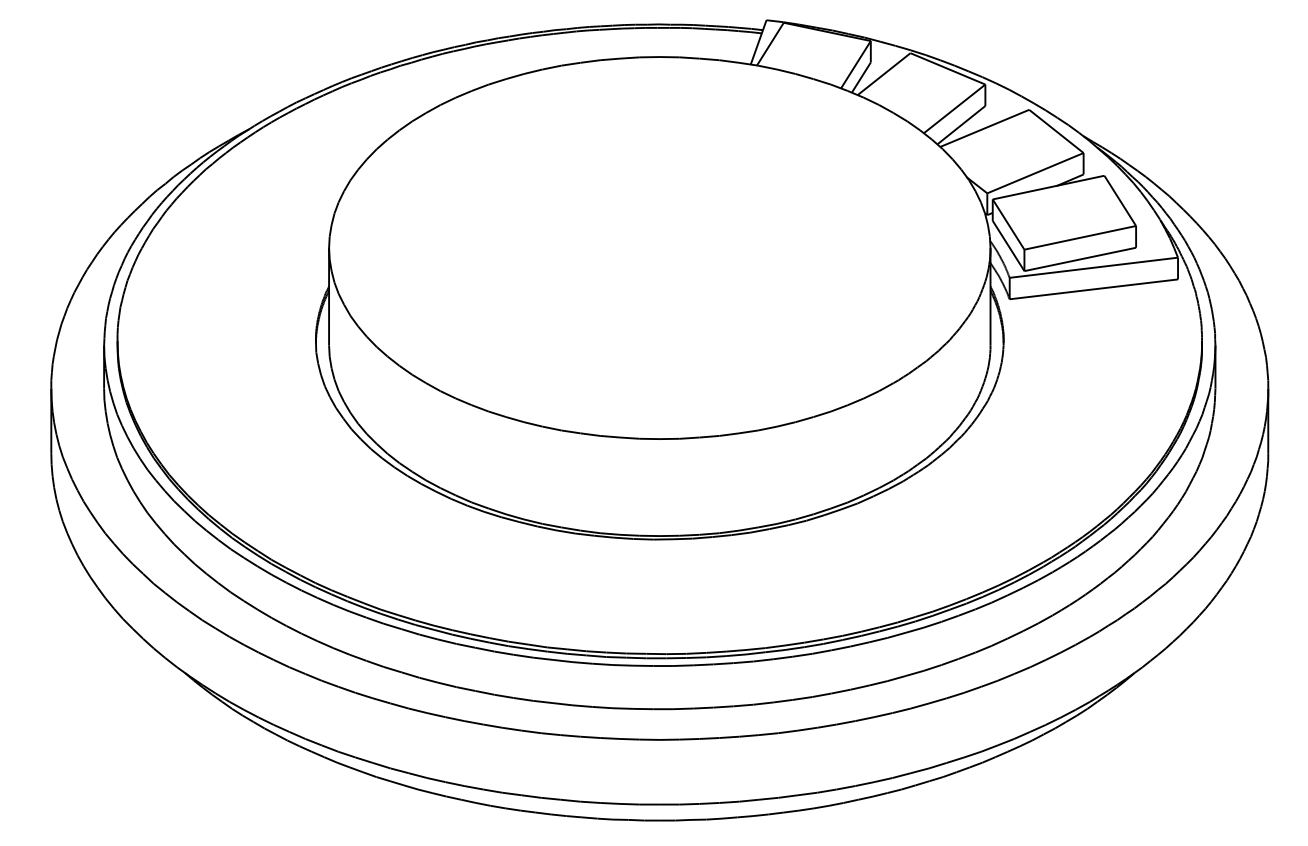
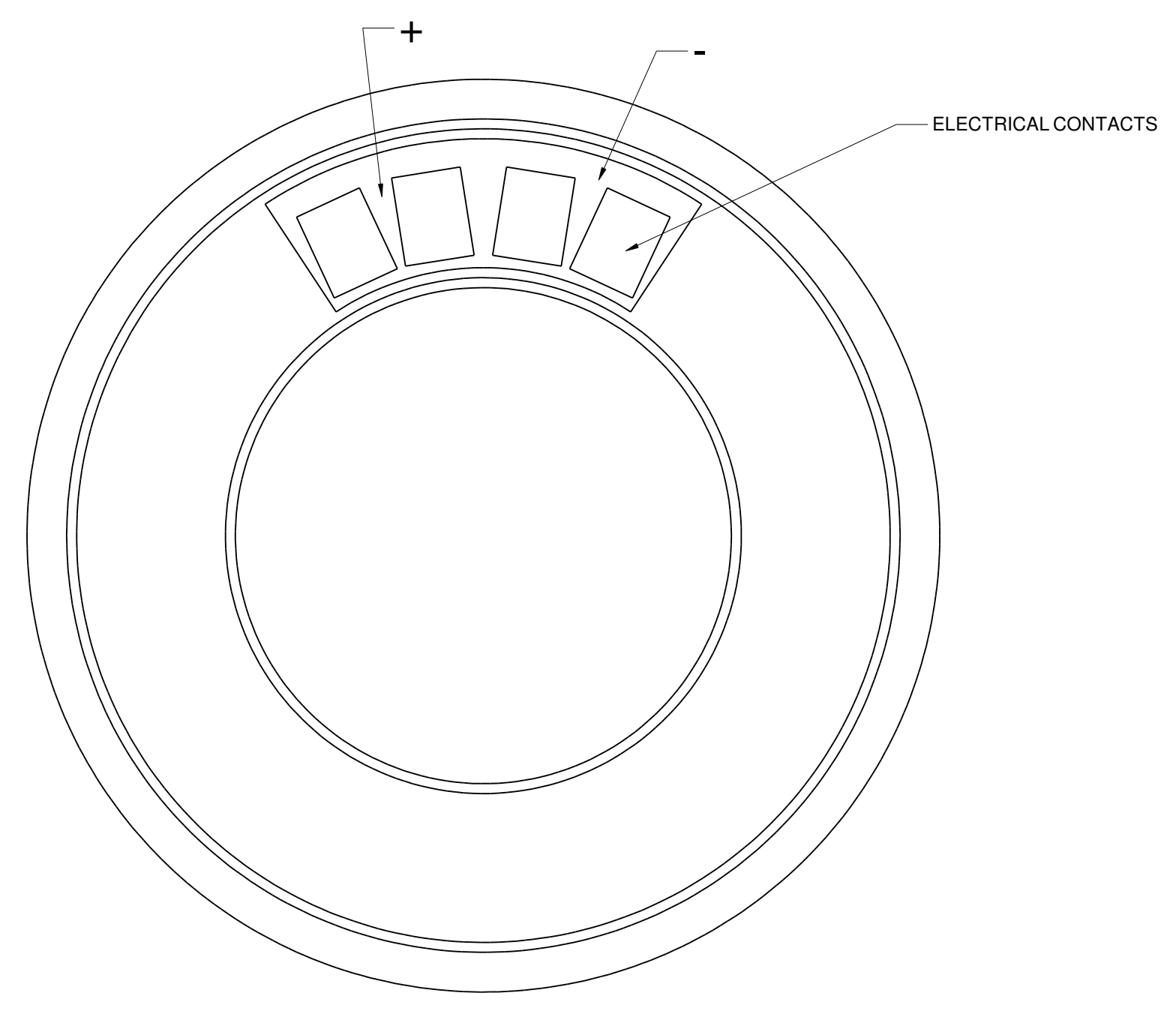

SIZE	FSCM NO.	DWG NO.	REV
D		SP-2306Y	
SCALE	SHEET		1 OF 1
1:1			