

REVISIONS				
ZONE	REV	DESCRIPTION	DATE	APPROVED

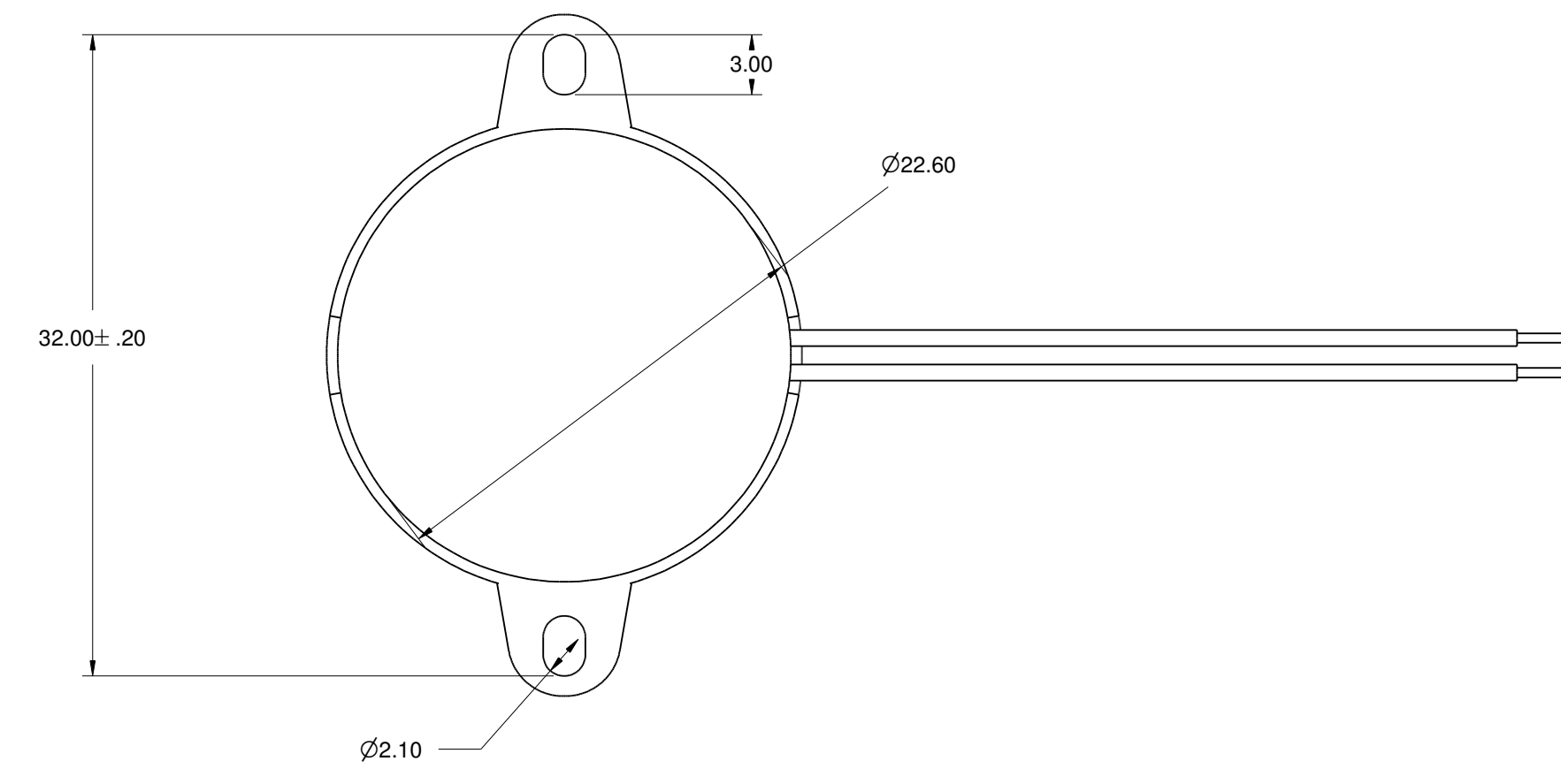
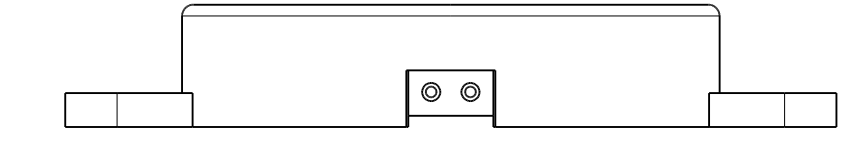
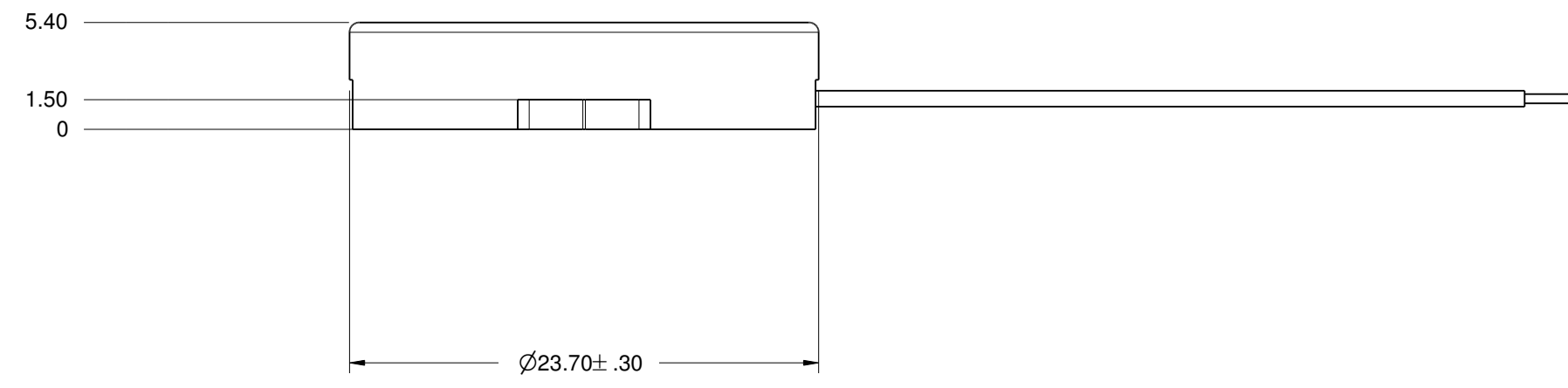
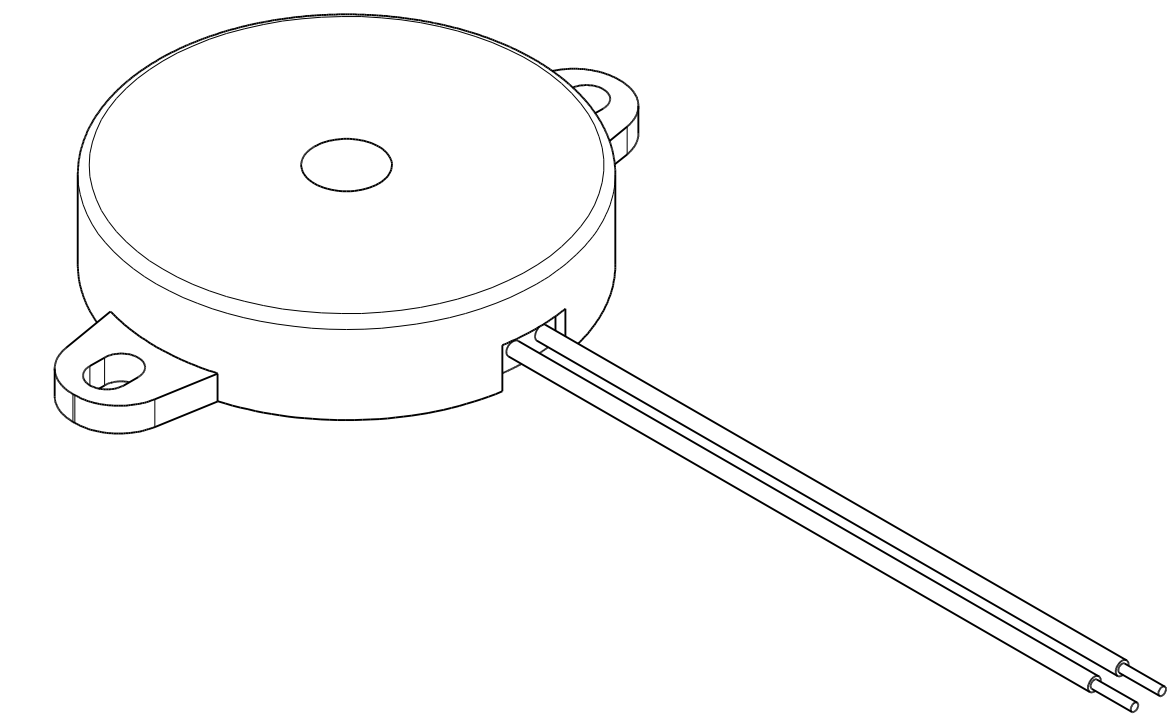
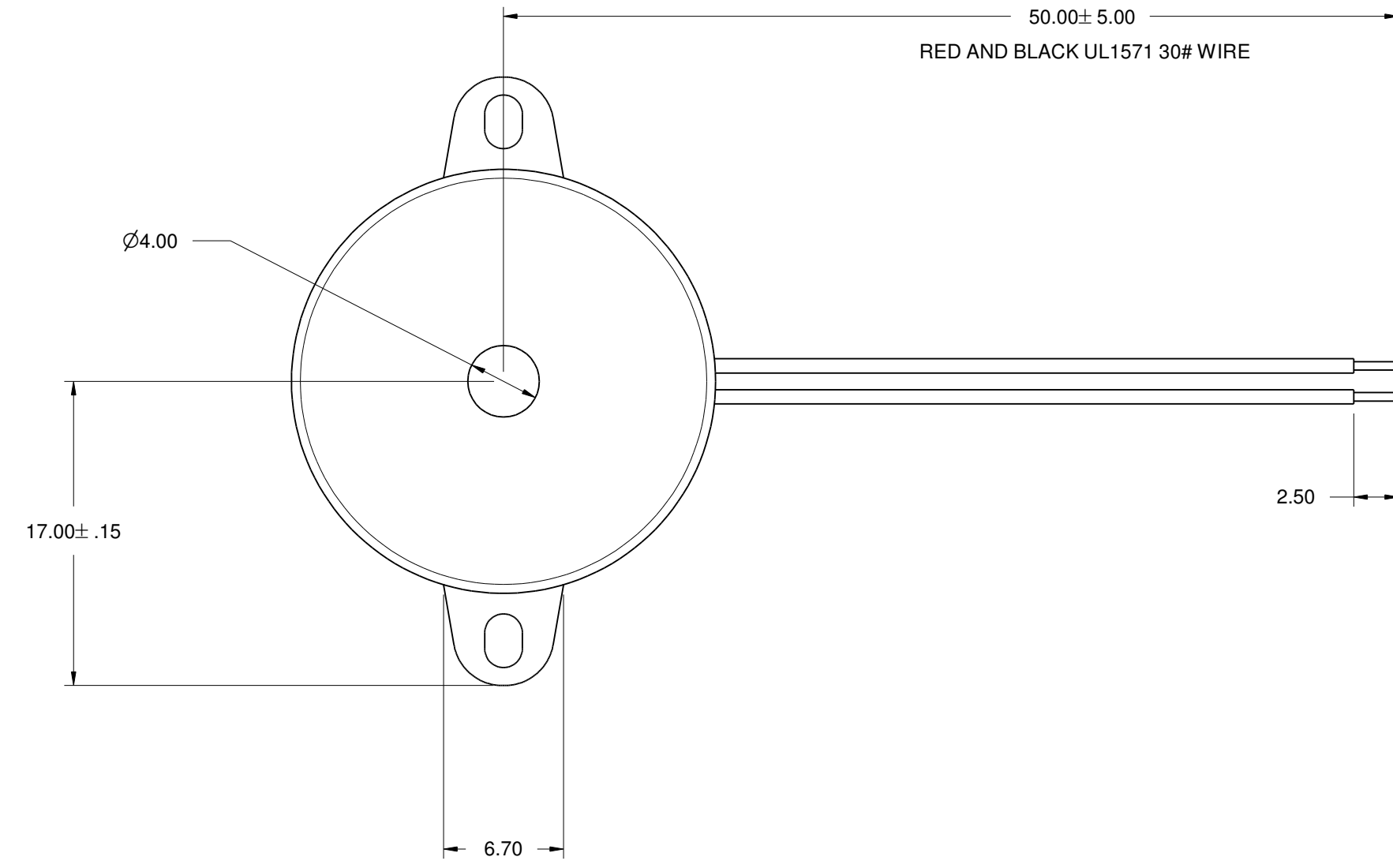

SIZE	FSCM NO.	DWG NO.	REV
D		PT-2404	
SCALE	1:1	SHEET	1 OF 1